

M67728

430-450MHz, 12.5V, 55W, SSB MOBILE RADIO

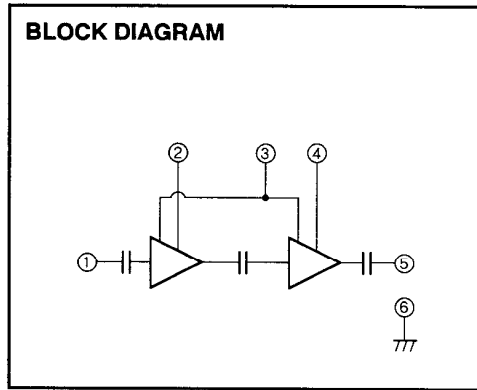
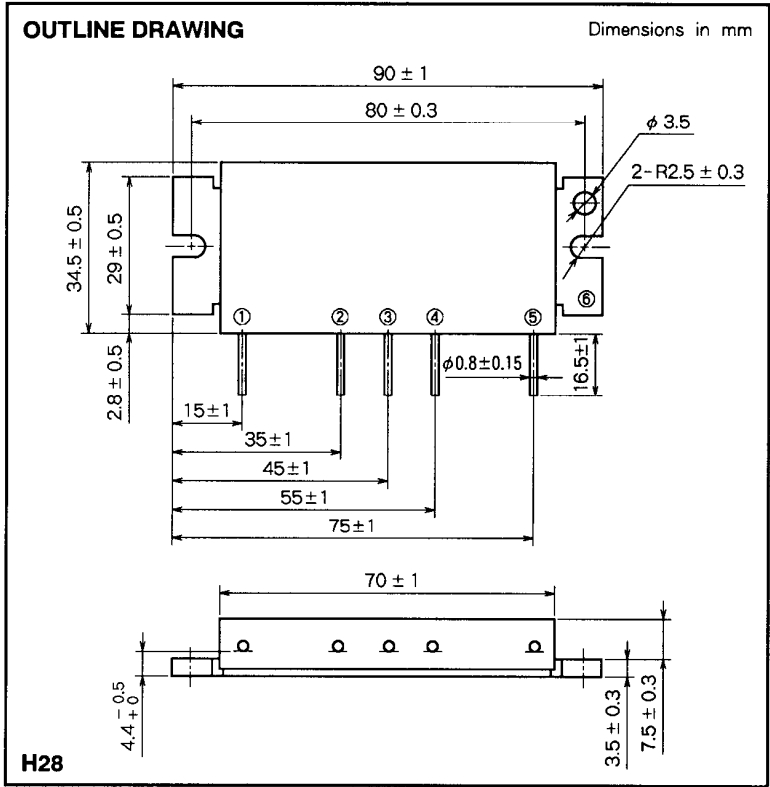

- PIN :
- ①Pin : RF INPUT
 - ②Vcc1 : 1st. DC SUPPLY
 - ③VBB : BASE BIAS SUPPLY
 - ④Vcc2 : 2nd. DC SUPPLY
 - ⑤Po : RF OUTPUT
 - ⑥GND : FIN

ABSOLUTE MAXIMUM RATINGS (Tc = 25°C unless otherwise noted)

Symbol	Parameter	Conditions	Ratings	Unit
Vcc	Supply voltage		16	V
VBB	Base bias		10	V
Icc	Total current		25	A
Pin(max)	Input power	ZG = ZL = 50 Ω, Vcc1 ≤ 12.5V	14	W
Po(max)	Output power	ZG = ZL = 50 Ω	78	W
Tc(OP)	Operation case temperature		- 30 to 110	°C
Tstg	Storage temperature		- 40 to 110	°C

Note. Above parameters are guaranteed independently.

ELECTRICAL CHARACTERISTICS (Tc = 25°C unless otherwise noted)

Symbol	Parameter	Test conditions	Limits		Unit
			Min	Max	
f	Frequency range	Pin = 10W VBB = 9V Vcc = 12.5V ZG = ZL = 50 Ω	430	450	MHz
Po	Output power		55		W
ηT	Total efficiency		40		%
2fo	2nd. harmonic		- 30		dBc
3fo	3rd. harmonic		- 35		dBc
ρin	Input VSWR		2.8		-
-	Load VSWR tolerance	Vcc1, 2 = 15.2V, VBB = 9V Po = 55W (Pin : controlled) Load VSWR = 8.8 : 1 (All phase), ZG = 50 Ω	No degradation or destroy		-

Note : Above parameters, ratings, limits and conditions are subject to change.

TYPICAL PERFORMANCE DATA

OUTPUT POWER, TOTAL EFFICIENCY, INPUT VSWR VS. FREQUENCY CHARACTERISTICS

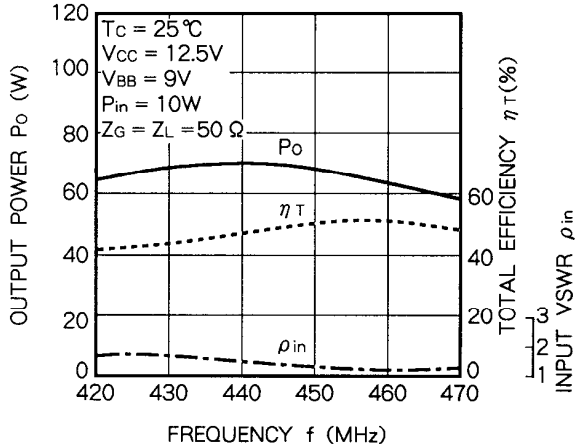

OUTPUT POWER, 1st, 2nd CURRENT VS. INPUT POWER CHARACTERISTICS

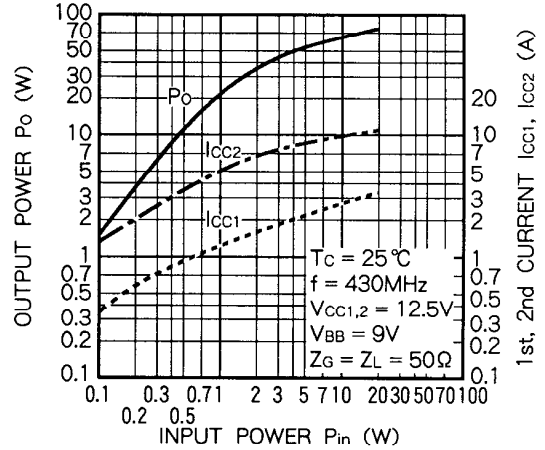

OUTPUT POWER, 1st, 2nd CURRENT VS. INPUT POWER CHARACTERISTICS

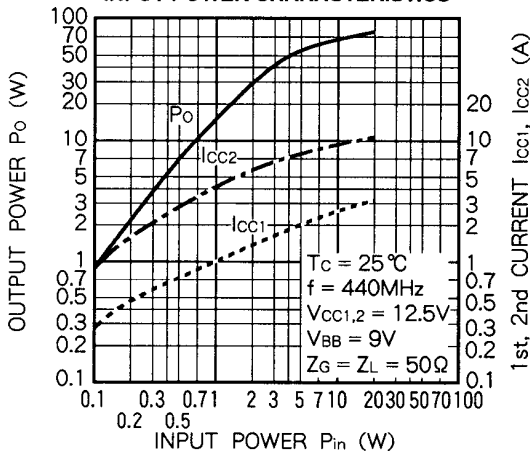

OUTPUT POWER, 1st, 2nd CURRENT VS. INPUT POWER CHARACTERISTICS

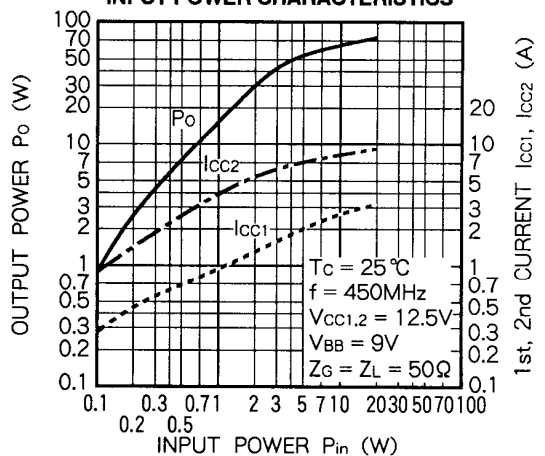

OUTPUT POWER, 1st, 2nd CURRENT VS. SUPPLY VOLTAGE CHARACTERISTICS

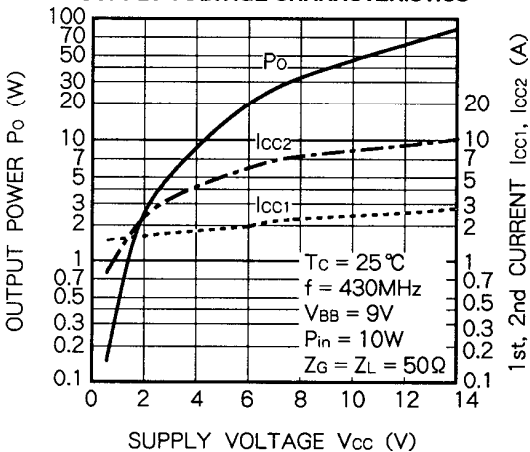

OUTPUT POWER, 1st, 2nd CURRENT VS. SUPPLY VOLTAGE CHARACTERISTICS

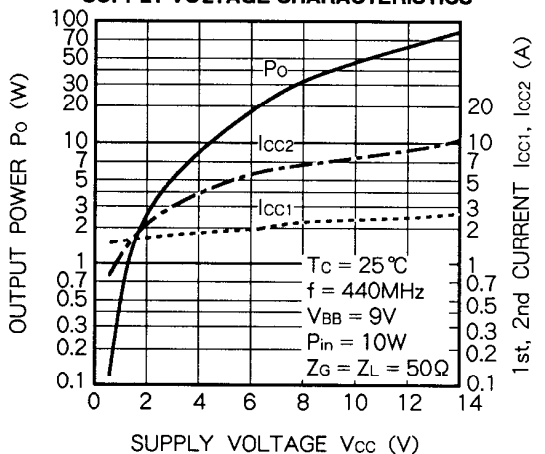

OUTPUT POWER, 1st, 2nd CURRENT VS. SUPPLY VOLTAGE CHARACTERISTICS

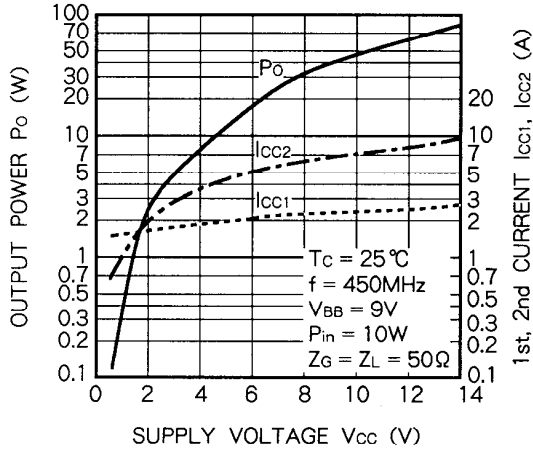

OUTPUT POWER, 1st, 2nd CURRENT VS. 1st SUPPLY VOLTAGE CHARACTERISTICS

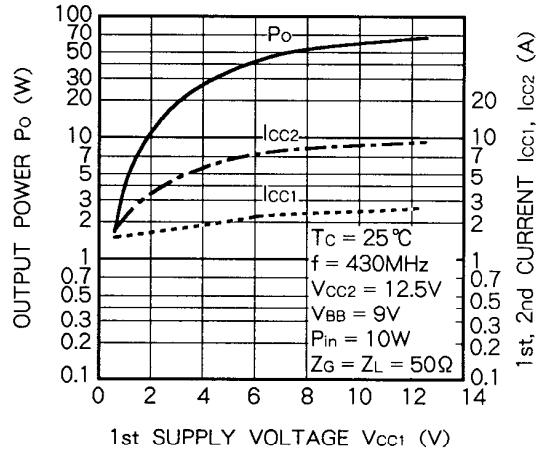

OUTPUT POWER, 1st, 2nd CURRENT VS. 1st SUPPLY VOLTAGE CHARACTERISTICS

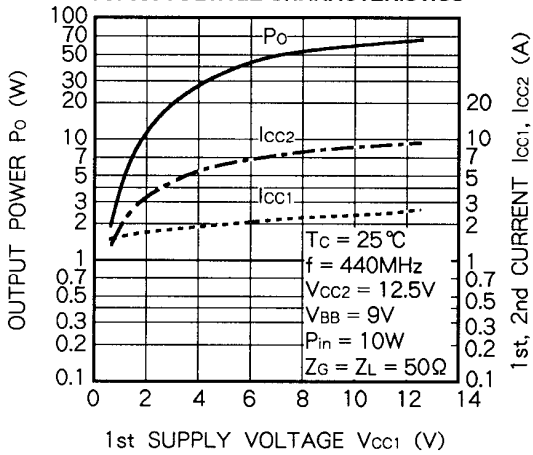

OUTPUT POWER, 1st, 2nd CURRENT VS. 1st SUPPLY VOLTAGE CHARACTERISTICS

